

# ACOUSTICAL PROBLEMS IN LARGE POST-WAR AUDITORIA

John O'Keefe Aercoustics Engineering Ltd., Toronto, Canada

## 1 INTRODUCTION

The period following World War II is surely one of the most exciting in the short history of acoustic research. In the space of thirty or more years, the phenomenon of sound in a room was demystified through a series of ground breaking discoveries. Academic and institutional research in the UK, Germany, New Zealand, Denmark and Canada, to name but a few, created the foundation of knowledge that acousticians rely on today. It is ironic therefore that the auditoria built during this time should have such lamentable reputations. The people who designed these buildings however were working in the dark, without the benefit of the information we take for granted today. To their credit, they learned along the way, each building being a little bit better than the last. Fifty years on, there is still much to learn from these rooms, using tools and ideas unheard of in their time.

This study will examine the acoustics of five typical multi-purpose rooms built between 1959 and 1972. Although all the halls described here were built in Canada, they are indicative of rooms built throughout the western world in the post-war era.

Almost without exception, these rooms were designed to direct energy to the back of the room with frontal overhead reflections. Rooms had been designed this way since the early part of the 20<sup>th</sup> century, Salle Pleyel in Paris being the first notable example. This was unfortunate because these frontal overhead reflections had the effect of shortening perceived reverberance, led to comb filtering and resulted in a harsh tone from the violins.

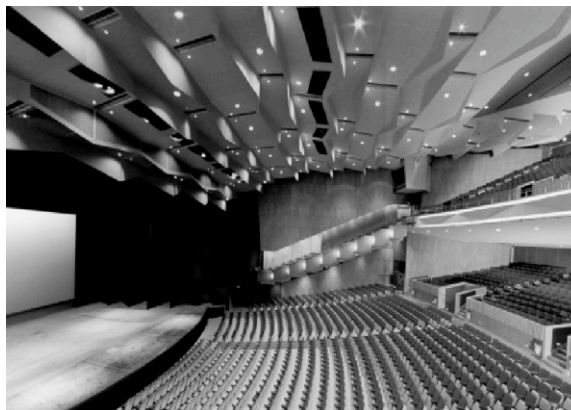

Figure 1 Queen Elizabeth Theatre, Vancouver, Canada

Many of these rooms are very wide with relatively low ceilings. A typical example is the Queen Elizabeth Theatre, opened in Vancouver in 1959<sup>1</sup> shown in Figure 1. As we will see, the height to width ratio of these rooms may explain many of their problems. A summary of the rooms studied here is shown in Table 1. (All data presented in this study is in the 500 Hz octave band.)

Table 1

	Seats	Volume (m3)	RT (s)	G (dB)
Jubilee Auditoria	2,700	30,473	1.35	-1.68
Queen Elizabeth Theatre	2,813	32,452	1.36	-1.86
Saskatoon Centennial*	2,014		1.79	-1.14
National Art Centre*	2,325	20,000 (37,452)	1.8	-0.55
Hummingbird Centre	3,167	36,319	1.2	-3.09

\* - orchestra shell installed, volumes without the shell shown in brackets

## 2 ACOUSTIC MEASUREMENTS

For post war acousticians, the Reverberation Time (RT) was the acoustic parameter of paramount concern. Certainly it was the only one that they could predict with any kind of confidence. Unfortunately, we now know that the Sabine's classical definition of RT does not correlate well with subjective Reverberance. In the early 1960s it was found that the first 160 ms of decay correlate much better with a listener's perception of Reverberance.<sup>2</sup> This led to Jordan's definition of Early Decay Time (EDT), using the first 10 dB of decay as opposed to Sabine's previous definition of 60 dB.

One of the interesting aspects of the post war rooms is that the RT is generally uniform throughout the space and, more often than not, is in the appropriate range. Unfortunately, the EDT, and hence the perception of reverberance, varies quite a bit and, more often than not, is significantly lower than the RT.

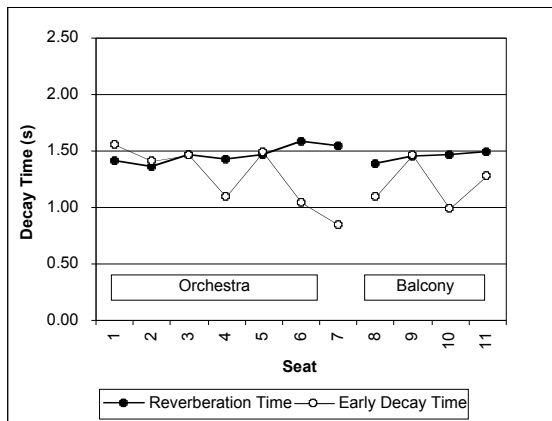

Figure 2 Reverberation and Early Decay Times measured in the Queen Elizabeth Theatre, Vancouver, Canada.

A fairly typical example is shown in Figure 2. In Vancouver's Queen Elizabeth Theatre the RT is around 1.5 seconds; which is not too bad if you're trying to reach a compromise between symphony and opera. Unfortunately, the EDT is much lower, in the range of 1.2 seconds and in many seats 1 second or less. In other words, unsuitable for symphony or opera. Toronto's Hummingbird (formerly O'Keefe) Centre has an average RT in the range of 1.2 seconds; EDTs are much lower. One seat on the balcony has an EDT of 0.24 seconds.

The subjective perception of Loudness is quantified by the objective parameter known as Strength (G). The generally accepted criterion for music is 0 dB or higher.<sup>3</sup> The best loved shoebox shaped halls of the 19<sup>th</sup> century, such as Vienna's Musikvereinssaal and Amsterdam's Concertgebouw have Strength levels in the range of +5 dB or slightly higher.<sup>4</sup> Figure 3 shows a compilation of Strength measurements from four large auditoria. Out of 133 measurement locations, 92 (69%) do not satisfy the 0 dB criterion. If the National Arts Centre data is taken out of the set, 89% of the measurements do not satisfy the criterion. Only a few seats – located again in the National Arts Centre – come close to the 5 dB level found in the preferred halls of the 19<sup>th</sup> century. In the Hummingbird Centre, not one of the 30 measurement locations satisfies the 0 dB criterion. To put the data in Figure 3 into context, remember that if we doubled the size of the orchestra, levels would only increase by 3 dB.

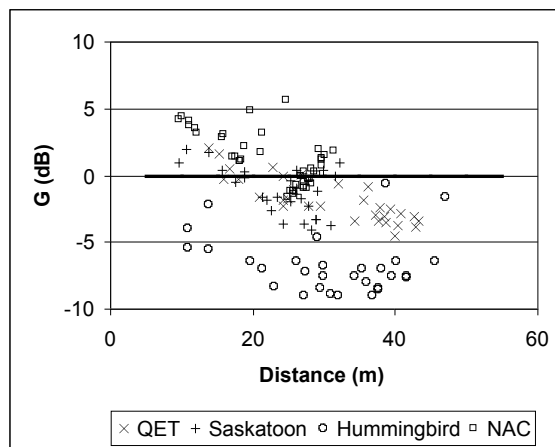

Figure 3 Strength measured in four Canadian post war auditoria. The arbitrary criterion for Strength is 0 dB indicated by the thick solid line. Data from Saskatoon and the National Arts Centre were measured with the orchestra shell in place. The Queen Elizabeth Theatre and Hummingbird Centre do not have orchestra shells.

One of the more fascinating measurement results in this study is shown in Figure 4. This is a comparison of late energy (Glate) in a typical mid 20<sup>th</sup> century fan shaped room (the Hummingbird Centre) to the three quintessential shoebox shaped rooms of the 19<sup>th</sup> century (Boston Symphony Hall, Vienna's Musikvereinssaal and Amsterdam's Concertgebouw). The difference between the two building types is enormous, in the range of 15 dB! This explains in part why some of the post-war rooms have problems with echoes. The paucity of late energy means that any reflection that does arrive at the listener after 80 ms will not have any other nearby reflections to mask it and hence will be heard as an echo. The problem is exacerbated by the large sizes of these buildings, which can often lead to strong reflections arriving around 150 to 200 ms.

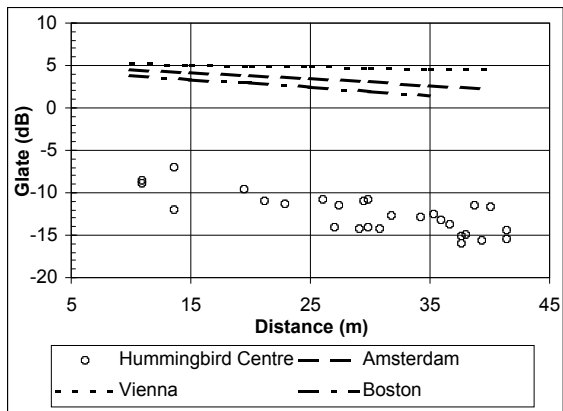

Figure 4 A comparison of late energy (Glate) in a mid 20<sup>th</sup> century fan shaped room with three of the best 19<sup>th</sup> shoebox shaped rooms.

Most of these rooms are characterised by higher than normal Clarity, as one might expect from a space with short EDTs and low Glate levels.

The lateral energy thesis is surely one of the most important developments of late 20<sup>th</sup> century acoustics. Early lateral energy has been associated with the spatial perception known as “source broadening”<sup>5</sup>, late lateral has been associated with the effect known as “envelopment”.<sup>6</sup> Early Lateral Fractions (ELF) are poor in some rooms examined here and better than one might expect in the others. For example, the 35 m (115’) wide Queen Elizabeth Theatre has an ELF of 0.16. Although not measured directly, one should also expect lower than acceptable Late Lateral Energy given the very low (omni-directional) Glate levels. We shall see that the impact of the lateral energy thesis extends beyond the immediate concerns with spatial impression.

### 3 EXPLANATIONS & SOLUTIONS

#### 3.1 Revised Theory

With the advantage of hindsight, we find a fairly simple explanation for one of the more important deficiencies of these rooms. The low Strength levels can be explained by a concept developed in the 1980s, known to us now as Revised Theory.<sup>7</sup> Like the classical theory of sound in a room, it tells us that Strength is proportional to Reverberation Time and inversely proportional to room volume. The innovation is that it also accounts for the change in reverberant level with distance. In classical theory only the direct sound attenuates with distance. In Revised Theory, both direct and reverberant levels decrease with distance.

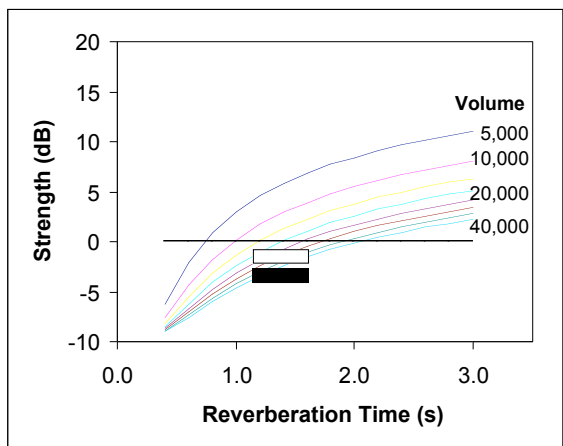

Figure 5 Revised Theory predictions of Strength in large rooms with short Reverberation Times, r=30 m. The white box indicates the levels expected in some of the halls studied here. The black box demonstrates the levels expected when the effects of height to width ratio are taken into account.

Figure 5 shows how Strength varies according to Volume and Reverberation Time for a given source receiver distance. Remember that the criterion for Strength is 0 dB or higher. The white rectangle shows the Strength levels that

Revised Theory predicts for five typical post war auditoria (the Jubilee Auditoria in Edmonton and Calgary<sup>1</sup>, Hummingbird, National Arts Centre and Queen Elizabeth Theatre). The calculation parameters are as follows: the rooms all have fairly high seat counts, in the range of 3000, so a source receiver distance of 30 m has been assumed; with the exception of the National Arts Centre, all of the rooms have short Reverberation Times, in the range of 1.3 seconds; all have very large volumes, in excess of 30,000 m<sup>3</sup>. (With Reverberation Times in the range of 1.3 seconds it is assumed that these multipurpose rooms are best suited for opera and hence, the volume of the flytower has been included.)

The results, shown in Figure 5 demonstrate the lethal combination of a large room with a short Reverberation Time. It can be seen that near the back of these rooms, even if everything turns out according to expectations, the best one can hope for is Strength below the accepted criterion of 0 dB. In most rooms, unfortunately, measured Strength is lower than predicted by Revised Theory.<sup>8</sup>

### 3.2 Increasing the Early Decay Time

Most post war auditoria were designed with reflectors near the front of the room. While there was a legitimate concern to direct sound towards the back of the room where it was needed, it led to some unfortunate side effects. One of these, as mentioned above, was a foreshortened Early Decay Time caused by the very early, mostly frontal, reflections.

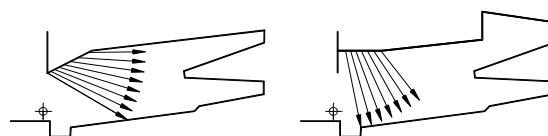

Figure 6 Longitudinal sections showing the existing Queen Elizabeth Theatre (right) and the first iteration of a renovation model experiment (left).

Figures 6 and 7 show one of the author's first experiments during the renovation design of Vancouver's Queen Elizabeth Theatre. On the left of Figure 6 one can see the existing ceiling configuration, directing sound towards the back of the room. The right hand side of Figure 6 shows the first version of the revised geometry, eliminating the frontal ceiling reflections. The results of the experiment are shown in Figure 7. EDT has been increased in 7 of 10 seats. In some seats EDT increased by as much as 0.5 seconds. The difference limen for Reverberance (i.e. EDT) is 0.1 seconds and is indicated in Figure 7 by the vertical error bars.

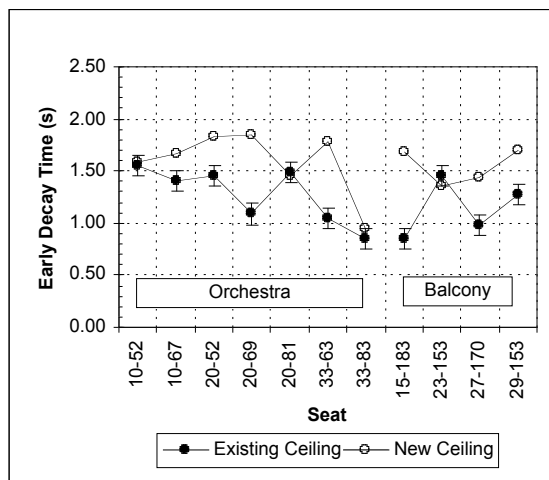

Figure 7 A comparison of Early Decay Times in a 1:48 scale model using the configurations shown in Figure 6.

### 3.3 The Effect of Height to Width Ratios

Another possible explanation for the post war problems comes from the author's study of height to width ratios.<sup>9</sup> In a series of experiments in both computer and scale models, using both fan and shoebox shaped rooms, it was found that the EDT/RT ratio can be related to the Height/Width ratio of the room. A compilation from computer and physical scale model experiments is shown in Figure 8.

Height to width ratios were also found to influence Strength. In the 1980s it was discovered that, contrary to what one might expect from classic theory, reverberant sound levels are not uniform throughout a room.<sup>7,10</sup> It was this finding, by the way, that led to Revised Theory. Sound levels were found to decrease at a rate of about 0.1 dB/m in a good room and more than 0.2 dB/m in a poorer room. It was thought that a fan shaped geometry might have something to do with this.

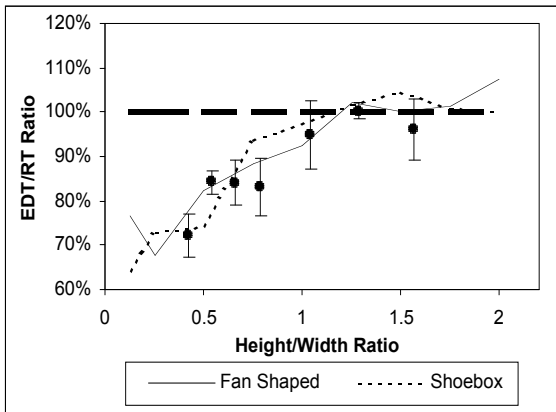

Figure 8 EDT/RT ratio vs. the Height/Width ratio of simple six sided fan and shoebbox shaped rooms. Computer model experiments are indicated by lines and the scale model measurement by dots.

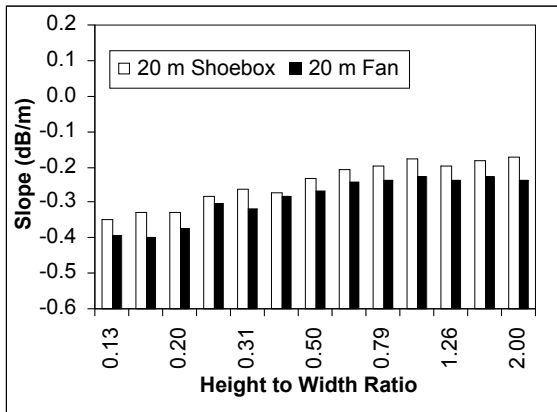

Figure 9 Computer model experiment showing the rate of attenuation of Strength (G) in 20 m wide fan and shoebbox shaped rooms of varying Height/Width ratios.

The height to width experiments help to explain this finding. Figure 9 shows the rate of attenuation of Strength (G) in fan and shoebbox shaped rooms for a range of height to width ratios. In the fan shape rooms, shown with the dark bars, the rate of attenuation is consistently higher than the shoebbox rooms. This leads to lower levels at the back of the fan shaped rooms and corroborates the 1980s postulate. But note how the Height/Width ratio has just as much, if not more of an effect on the rate of attenuation.

The height to width experiments also help to explain the discrepancy between Revised Theory prediction of Strength and *in situ* measurements. Figure 10 demonstrates the difference between Revised Theory predictions and scale model measurements. The difference between the predictions and measurements increases as the Height/Width ratio of the room is decreased. The same results were found in computer model experiments, also shown in Figure 10.

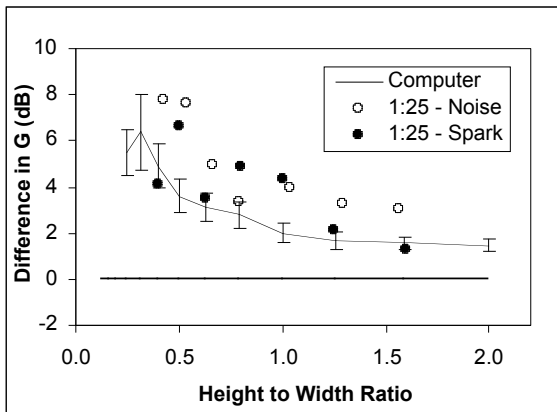

Figure 10 A comparison between Strength (G) predicted by Revised Theory to calculations by a hybrid method of images/ray tracing computer model and measurements in a 1:25 scale model.

To summarise, in a wide, flat room one can expect the EDT to be much shorter than the RT, EDT/RT ratios could be in the range of 70 to 80%. This implies poor Reverberance. The rate of attenuation of Strength will be high, perhaps in the range of 0.25 dB/m or more. At the back of a large hall (e.g. 35 m long) this corresponds to a decrease of 8.75 dB, while a good hall (with an attenuation rate of 0.1 dB/m) might only exhibit a 3.5 dB decrease in level. That means that the Strength at the back of a low wide room will be slightly more than 5 dB lower than a tall narrow room of the same length. Remember again that doubling the size of the entire orchestra will only increase the level by 3 dB. Finally, in the wide, flat room we can expect Revised Theory to over-predict Strength levels. Recall in Figure 5 that Revised Theory suggested less than desirable Strength in the five post war venues under study. The white box in Figure 5 indicates the Strength predicted for these rooms by Revised Theory. Taking the effects of Height/Width ratios into account, Strength will be even lower, as indicated by the black box in Figure 5, i.e. in the range of -3 dB.

Many of the large post auditoria were wide and flat. Height/Width ratios in the range of 40% or lower were not uncommon. The fan shaped geometries are particularly problematic. In these

rooms, Height/Width ratios decrease towards the back of the room. Unfortunately, in a fan shaped room, most of the people sit at the back. That's where the balcony is located and that's where the room is at its widest.

The Hummingbird Centre provides an interesting example. Looking at the photograph in Figure 11, one might be fooled into thinking that the room has a reasonable Height/Width ratio. Figure 12 shows an iconic representation of the actual Height/Width ratios. At the front of the room, where the camera is pointing, the Height/Width ratio is 46%. In Figure 12 this is indicated by the white rectangle. At the back of the room, where the camera is actually located, the ratio is only 9%, indicated by the black rectangle in Figure 12. The experiments described above suggest that a 9% Height/Width ratio should lead to an EDT/RT ratio in the range of 60%. Measurement taken in this location reveal EDT/RT ratios slightly lower than that: 57% near the camera 50% a bit further back.



Figure 11 The Hummingbird (formerly O'Keefe) Centre prior to the 1996 renovation.

### 3.4 Stage to Pit Balance

The fan shape geometry also proves problematic for Stage to Pit Balance. A simple first order method of images exercise is shown in Figure 13. It shows the comparison of a 30° fan shaped geometry to a rectangular plan of the same size. The hatch marks in the top row indicate the reflections cast off the side wall when the sound source is located in the orchestra pit. The bottom row demonstrates the same for a sound source located slightly upstage of the proscenium arch. Note how the reflection coverage is much more sensitive to source location in the fan shaped room, compared to the rectangular room. From this, one might expect Stage to Pit Balance to be poor in a fan shaped room. At least one set of measurements indicates that this might not always be the case. The reason why proves interesting.

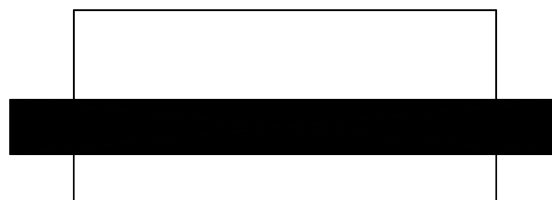

Figure 12 Height/Width rectangles at the front and back of the Hummingbird Centre.

Stage to Pit Balance measurements in the fan shaped Hummingbird Centre are fairly high. Higher than 3 other halls measured in a 1995 survey of Canadian theatres,<sup>11</sup> all of which are rectangular in plan. Of the four halls, the Hummingbird Centre had the lowest G and Glate.

Table 2

Theatre	B (dB)	
	Orchestra	Balcony
McPherson	-0.9	-0.2
Royal	2.0	1.5
Saskatoon	-2.6	-2.1
Hummingbird	2.8	3.7

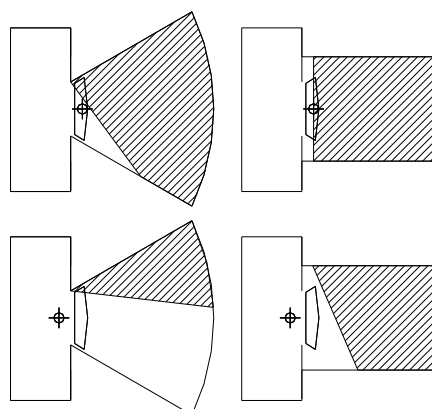

Figure 13 Reflection zones cast off the side wall of a 30° fan shaped room and a rectangular room. In the fan shaped room sound sources in the pit have a larger reflection zone than singers on stage.

It turns out that the Balance between stage and pit sources is strongly influenced by reflected sound energy, both early and late. This was demonstrated by the author in a hemi-anechoic 1:25 model.<sup>12</sup> In the first part of the experiment the walls and ceiling of the model were lined with the full scale equivalent of 1.5 m deep glass fibre. The floor consisted of a hard stage and an upholstered seating area. In the second part of the experiment, the glass fibre was removed from the ceiling and the walls were left absorbent. The purpose of the experiment was to demonstrate the importance of ceiling reflection(s) on Stage to Pit Balance. The results are shown in Figure 14.

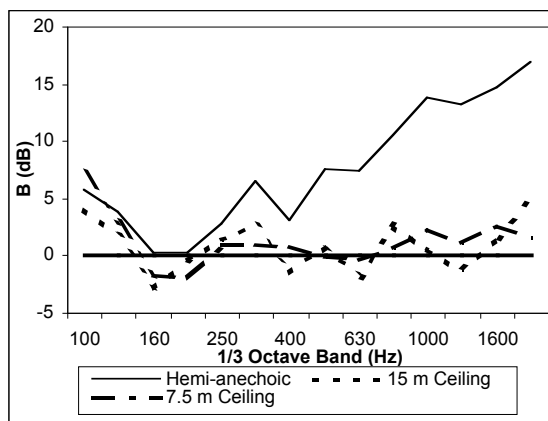

Figure 14 Balance measurements (B) in a 1:25 scale model demonstrate the importance of reflected sound.

The solid line indicates the Balance in the hemi-anechoic space, i.e. the Balance between the direct sound coming from the stage and the pit. The dashed lines indicate the Balance measured with two different hard ceilings, one that is 7.5 m high (full scale) and the other 15 m high. Without the benefit of reflected sound, Balance tips heavily in favour of the stage (solid line). One sees uncharacteristically high Balance levels and clear evidence of barrier effect on the pit source. With the benefit of ceiling reflections (dashed lines), Balance is shown to be in the 0 to 2 dB range that one is more likely to encounter in a theatre or opera house.

Returning to the case of the fan shaped Hummingbird Centre, recall that reflected sound energy (G) is low and that late reflected energy (Glate) is particularly low. The Balance experiment described above suggests that, just like Clarity (C80) measurements in these rooms, good Balance is generated not by strong early reflections but rather as a consequence of weak late reflections.

## 4 REVIEW

If one accepts the height to width ratio concept presented above, it is hard to over-emphasise the influence of the lateral energy thesis. In the last quarter of the 20<sup>th</sup> century acoustical design gravitated towards tall, narrow rooms. Many of the designers did this trying to maximise spatial impression, as suggested by the lateral energy thesis. This was fortuitous because the problems with wide, relatively low ceiling geometries spreads far beyond the concerns about spatial impression.

In trying to satisfy the single requirement of early lateral reflections, acousticians got a five fold return:

1. The narrow room provided early lateral reflections which led to source broadening, as intended.
2. It also led to strong late lateral energy which generated envelopment, an effect that wasn't known until the mid 1990s.<sup>6</sup>
3. A tall narrow room meant that the Early Decay Time was much closer to the Reverberation Time. As a result the room sounded more reverberant and the decay of sound was smoother. This the designers could not have known at the time, except perhaps on an intuitive level.
4. The tall narrow room also meant that the rate of attenuation of the reverberant sound level was much lower and, as a result, Strength at the back of the room was higher. Again, it's unlikely the designers knew this at the time.
5. Finally, since the introduction of Revised Theory in the middle 1980s, acousticians may have had over-optimistic expectations of acoustic Strength. If they opted for a wide, low ceiling room design, Revised Theory would have seriously overestimated the Strength. If, on the other hand, they chose a tall narrow building, Revised Theory would provide a much better prediction of Strength, albeit slightly high.

## 5 SUMMARY

The lamentable reputation of four representative post war auditoria has been confirmed by acoustical measurements. Of the four or five parameters now thought to be important, only one - Reverberation Time (RT) – was found to be in the appropriate range. Coincidentally, it was also the only parameter thought to be important when these rooms were built and the only one that could be easily predicted before the age of computers. Early Decay Times (EDT) were found to be shorter than Reverberation Times in all four halls and, in most cases varied significantly from seat to seat. Strength (G) was found to be consistently low, lower than generally accepted criterion of 0 dB and much lower than the 5 dB levels found in the preferred shoebox shaped rooms of the 19<sup>th</sup> century. Clarity was high, Early Lateral Fractions were generally low and Late Lateral Energy, although, not measured directly, can be expected to be low based on the low (omni-directional) Late Energy (Glate) measurements.

A simple exercise using Revised Theory explains the low G levels through the unfortunate combination of a large volume, a short Reverberation Time and long distances. Many of the post war rooms had a low Height/Width ratio, which has been correlated with poor EDT/RT ratios and low G. EDTs were also shortened by early reflections generated by reflectors located at front of many of these rooms. A simple ray tracing exercise suggests that the fan shaped geometry typically used in this era favours sound from the pit over sound from the stage. Measurements in at least one room however shows measured Stage to Pit Balance in favour the stage. The reason for the discrepancy is a lack of reflected energy (G and Glate).

The problem with these post war facilities was never really solved. With the notable exception of California's Segerstrom Hall, the building type was simply abandoned. The lateral energy thesis, introduced in the early 1970s proved to be one of the great turning points in modern acoustics. It dictated that rooms should be narrow to encourage strong early lateral reflections. In so doing, it also led to longer Early Decay Times, higher Strength and, most likely, higher Late Lateral Energy. In short, the tall narrow geometry provides a much more efficient use of reflected acoustic energy.

## 6 REFERENCES AND ACKNOWLEDGEMENTS

1. Beranek L.L., Music Acoustics and Architecture New York 1960
2. Atal, B.S., Schroeder, M.R. & Sessler, G.M., "Subjective Reverberation Time and its Relation to Sound Decay", Proc. 5th International Congress on Acoustics, Liege, Paper G32
3. Barron, M., Auditorium Acoustics and Architectural Design, London, E&FN Spon (1993).
4. Beranek, L.L., Concert and Opera Halls, How they Sound, Acoust. Soc. Am. New York (96)
5. Barron, M. "The subjective effects of first reflections in concert halls - the need for lateral reflections", J. Sound & Vibration 15, pp 481-502
6. Bradley, J.S., Soulodre, G.A. "Influence of late arriving energy on spatial impression", J. Acoust. Soc. Am, 97 p.2263-2271 (1995)
7. Barron, M., Lee, L.J. 'Energy relations in concert auditoriums. Part I', J. Acoust. Soc. Am. 84, pp 618-628 (1988)
8. Hyde, J.R. "A Look at Components of Sound Strength in Concert Halls Through Acoustical Measurements and Computer Modelling", Proc. Inst. of Acoustics, Manchester, Oct. 1999
9. O'Keefe, J., "The Influence of Height to Width Ratio and Side Wall Boxes on Room Acoustics Measurements", Proc. Inst. of Acoustics, Manchester, Oct. 1999
10. Bradley, J.S. 'Hall Average Conditions of 10 Halls', Proc. 13th Int. Congress on Acoustics 2 pp 199-02, Belgrade (1989)
11. O'Keefe, J., "Measurement of Stage to Pit Balance in Four Proscenium Arch Theatres", Proc. Inst. of Acoustics, 19, Pt. 3, pp 145-151 (1997)
12. O'Keefe, J., "Small scale modelling of stage to pit balance - a pilot study", Proc. 16th International Congress on Acoustics, Seattle, USA, pp 341-342, (1998)

I would like to thank John Bradley for kindly providing the National Arts Centre measurements.